

| Number | Modify Description | Modify | Auditing | Confirm | Date |
|--------|--------------------|--------|----------|---------|------|
| | | | | | |
| | | | | | |

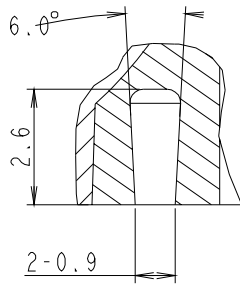

"B" Detail

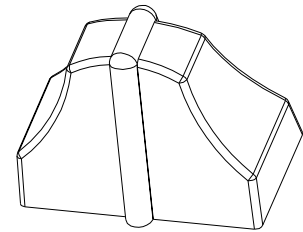
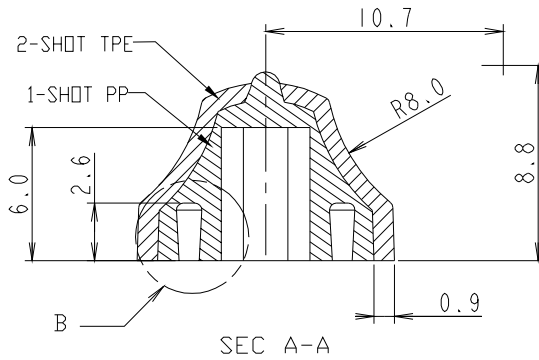
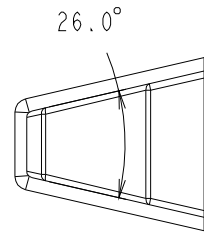
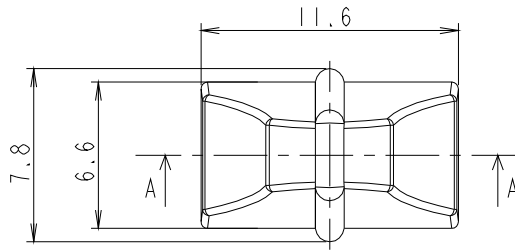
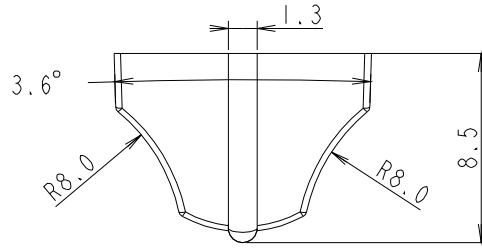
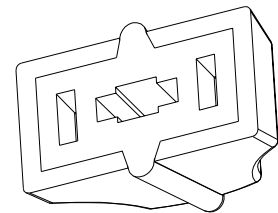
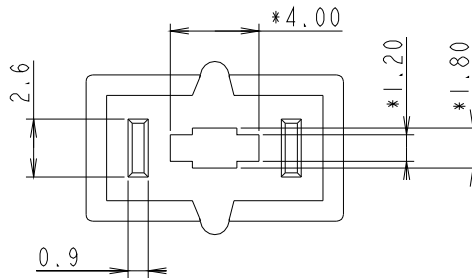

Devlin Electronics LTD

| | | | |
|--|----------------|-----------------|-------------------------------------|
| PART TITLE: 3/LK 070 03 | | MATERIAL: XXX | |
| TOLERANCES: X.X ±0.2 X.XX ±0.1 X.XXX ±0.05 ANGLE X.X ±0.5° X.XX ±0.1° | DESIGNED: Alan | DATE: 26-5-2020 | SHRINKAGE: XXXX |
| | CHECKED: | DATE: | PART NO: K57060 |
| | APPROVED: | DATE: | MOULD NO: XXXXXXXXXX |
| PROJECTION | UNIT: MM | SIZE: A4 | SCALE: 3:1 |
| | | | SHEET: <u> 1 </u> OF <u> 1 </u> |

MATERIAL 1:
20% TALC FILLED POLYPROPYLENE AT PP HA4920/200

MATERIAL 2:
TPE SANTOPRENE NATURAL 201-64